

Vazão: 70 lpm
 Pressão: 350 bar

Esquema Hidráulico

F1 Normalmente Fechada

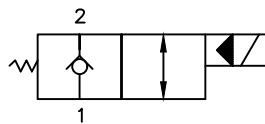

A1 Normalmente Aberta

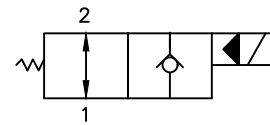

Bobinas

A Conector: ISO4400

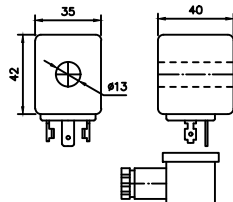

B Conector: Deutsch DT04

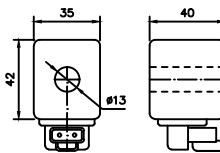

Características Bobinas:

Potência Nominal: 21W
 Isolamento: ClasseH(180°)
 Proteção: IP65

Volts	Corrente Nominal
12 VCC	1,75A
24 VCC	0,87A
220 VCA	0,09A
110 VCA	0,19A

Cavidade SAE 10/2

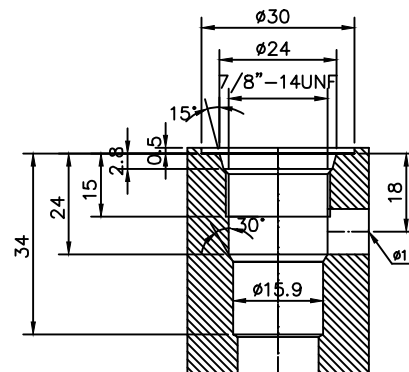

Como Solicitar

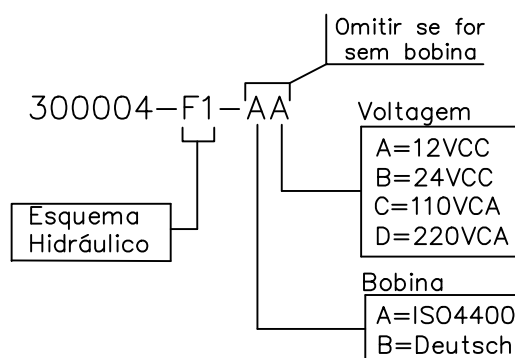

Control Star

Denominação:
 Válvula Solenóide SAE10/2

Código:
 300004-